

## Features

- Low On-Resistance
  - 7mΩ @  $V_{GS} = 10V$
  - 10mΩ @  $V_{GS} = 4.5V$
- Low Gate Threshold Voltage
- Low Input Capacitance
- Fast Switching Speed
- Low Input/Output Leakage
- **Lead Free By Design/RoHS Compliant (Note 2)**
- **"Green" Device (Note 4)**
- **Qualified to AEC-Q101 Standards for High Reliability**

## Mechanical Data

- Case: SOP-8L
- Case Material: Molded Plastic, "Green" Molding Compound. UL Flammability Classification Rating 94V-0
- Moisture Sensitivity: Level 1 per J-STD-020D
- Terminals Connections: See Diagram
- Terminals: Finish - Matte Tin annealed over Copper lead frame. Solderable per MIL-STD-202, Method 208
- Marking Information: See Page 4
- Ordering Information: See Page 4
- Weight: 0.072g (approximate)

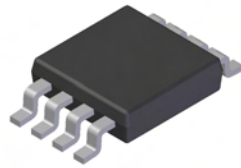

TOP VIEW

SOP-8L

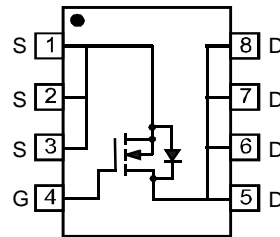
 TOP VIEW  
Internal Schematic

## Maximum Ratings @ $T_A = 25^\circ C$ unless otherwise specified

Characteristic			Symbol	Value	Units
Drain-Source Voltage			$V_{DSS}$	30	V
Gate-Source Voltage			$V_{GSS}$	$\pm 20$	V
Drain Current (Note 1)	Steady State	$T_A = 25^\circ C$	$I_D$	16	A
		$T_A = 70^\circ C$		13	
Pulsed Drain Current (Note 3)			$I_{DM}$	64	A

## Thermal Characteristics

Characteristic	Symbol	Value	Unit
Total Power Dissipation (Note 1)	$P_D$	2.5	W
Thermal Resistance, Junction to Ambient	$R_{\theta JA}$	50	$^\circ C/W$
Operating and Storage Temperature Range	$T_J, T_{STG}$	-55 to +150	$^\circ C$

- Notes:
1. Device mounted on 2 oz. Copper pads on FR-4 PCB, with  $R_{\theta JA} = 50^\circ C$
  2. No purposefully added lead.
  3. Pulse width  $\leq 10\mu S$ , Duty Cycle  $\leq 1\%$ .
  4. Diodes Inc.'s "Green" policy can be found on our website at [http://www.diodes.com/products/lead\\_free/index.php](http://www.diodes.com/products/lead_free/index.php).

**Electrical Characteristics** @ $T_A = 25^\circ\text{C}$  unless otherwise specified

Characteristic	Symbol	Min	Typ	Max	Unit	Test Condition
<b>OFF CHARACTERISTICS (Note 5)</b>						
Drain-Source Breakdown Voltage	$BV_{DSS}$	30	—	—	V	$V_{GS} = 0V, I_D = 250\mu A$
Zero Gate Voltage Drain Current	$I_{DSS}$	—	—	1	$\mu A$	$V_{DS} = 30V, V_{GS} = 0V$
Gate-Source Leakage	$I_{GSS}$	—	—	$\pm 100$	nA	$V_{GS} = \pm 20V, V_{DS} = 0V$
<b>ON CHARACTERISTICS (Note 5)</b>						
Gate Threshold Voltage	$V_{GS(th)}$	1.3	—	2.1	V	$V_{DS} = V_{GS}, I_D = 250\mu A$
Static Drain-Source On-Resistance	$R_{DS(on)}$	—	5 7.9	7 10	m $\Omega$	$V_{GS} = 10V, I_D = 15A$ $V_{GS} = 4.5V, I_D = 13A$
Forward Transconductance	$g_{fs}$	—	16.4	—	S	$V_{DS} = 10V, I_D = 15A$
Diode Forward Voltage (Note 5)	$V_{SD}$	—	0.67	1.2	V	$V_{GS} = 0V, I_S = 2.3A$
<b>DYNAMIC CHARACTERISTICS</b>						
Input Capacitance	$C_{iss}$	—	2714	—	pF	$V_{DS} = 15V, V_{GS} = 0V$ $f = 1.0MHz$
Output Capacitance	$C_{oss}$	—	436	—	pF	
Reverse Transfer Capacitance	$C_{rss}$	—	380	—	pF	
Gate Resistance	$R_G$	—	0.7	—	$\Omega$	$V_{DS} = 0V, V_{GS} = 0V, f = 1.0MHz$
<b>SWITCHING CHARACTERISTICS</b>						
Total Gate Charge	$Q_g$	—	31.2 64.2	—	nC	$V_{DS} = 15V, V_{GS} = 4.5V, I_D = 16A$ $V_{DS} = 15V, V_{GS} = 10V, I_D = 16A$
Gate-Source Charge	$Q_{gs}$	—	7.1	—		$V_{DS} = 15V, V_{GS} = 10V, I_D = 16A$
Gate-Drain Charge	$Q_{gd}$	—	17.1	—		$V_{DS} = 15V, V_{GS} = 10V, I_D = 16A$
Turn-On Delay Time	$t_{d(on)}$	—	10.3	—	ns	$V_{DS} = 15V, V_{GS} = 10V,$ $I_D = 1A, R_G = 6.0\Omega$
Rise Time	$t_r$	—	14.8	—		
Turn-Off Delay Time	$t_{d(off)}$	—	85.1	—		
Fall Time	$t_f$	—	43.6	—		

Notes: 5. Short duration pulse test used to minimize self-heating effect.

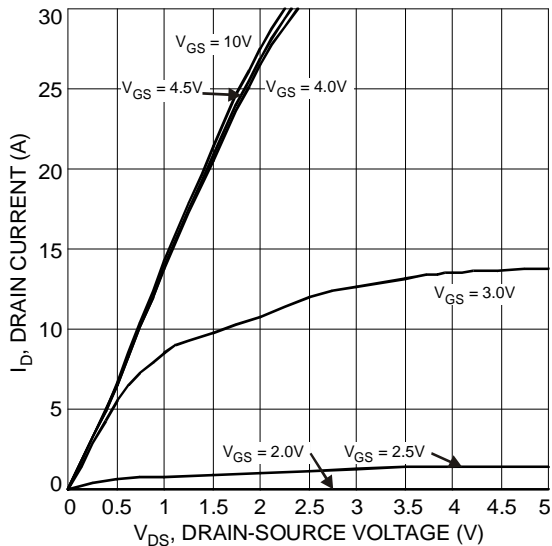

Fig. 1 Typical Output Characteristic

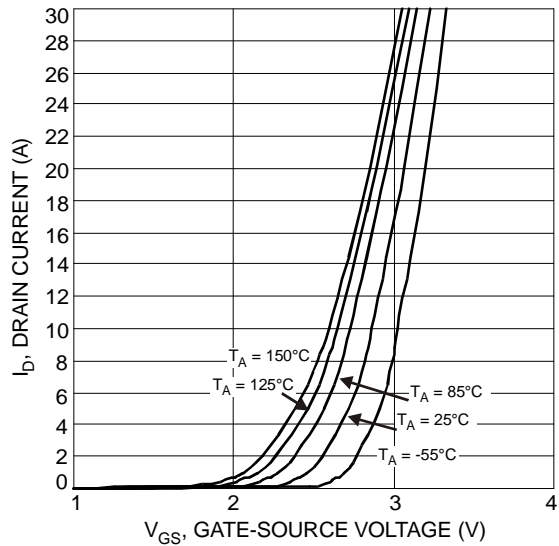
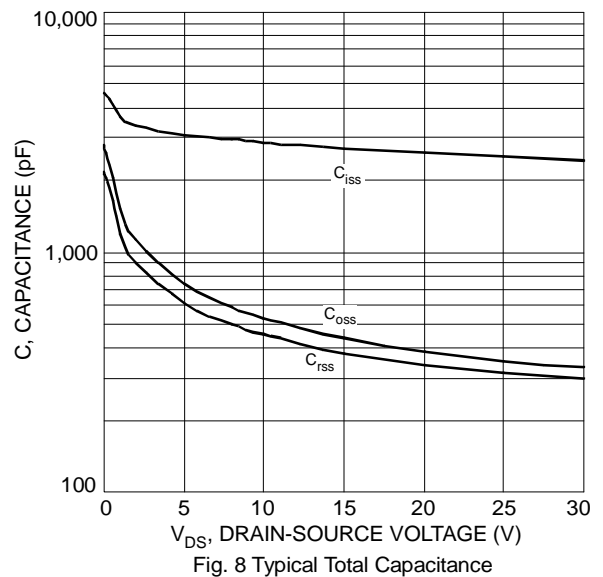
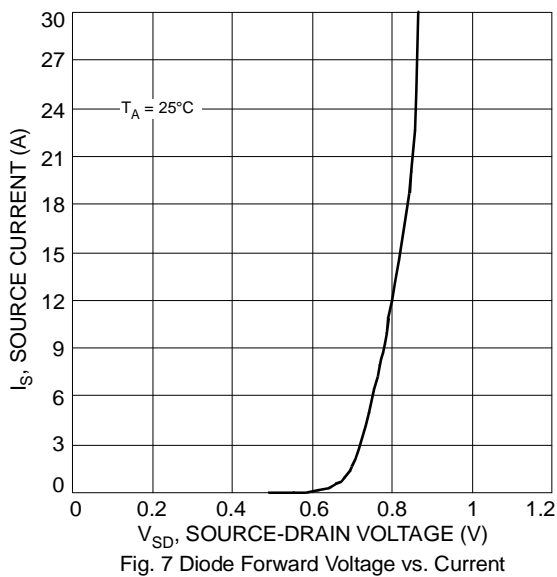
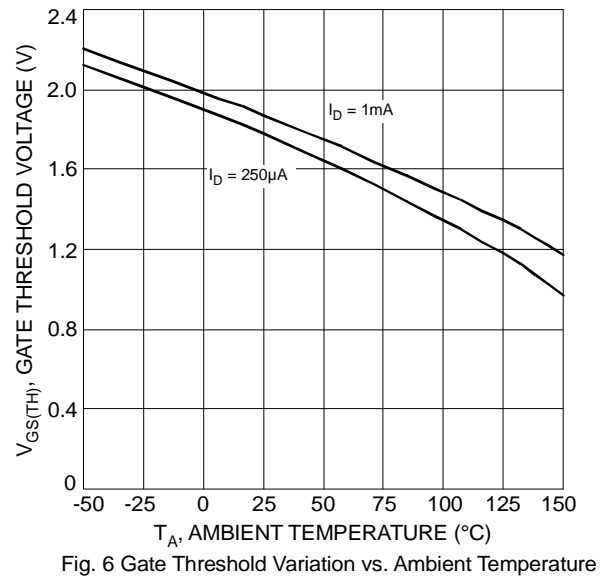
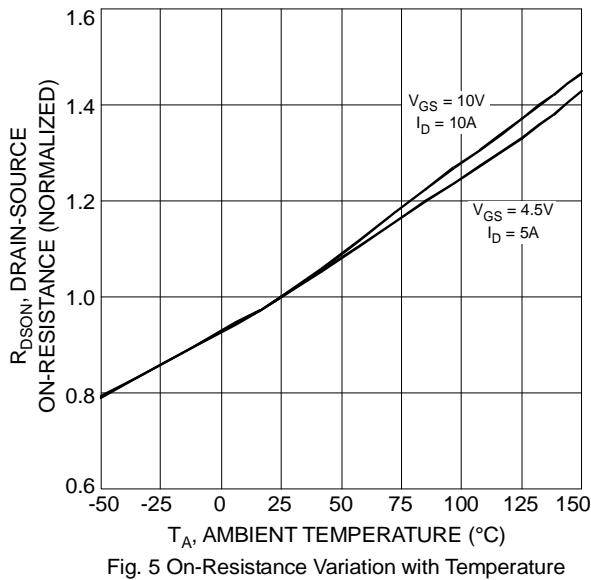
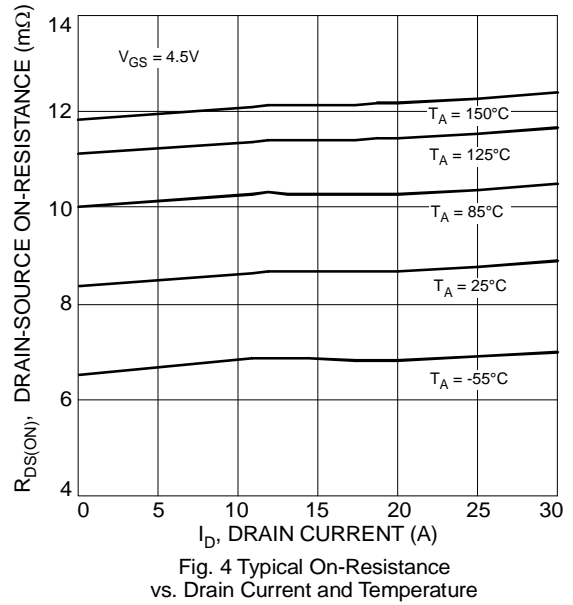
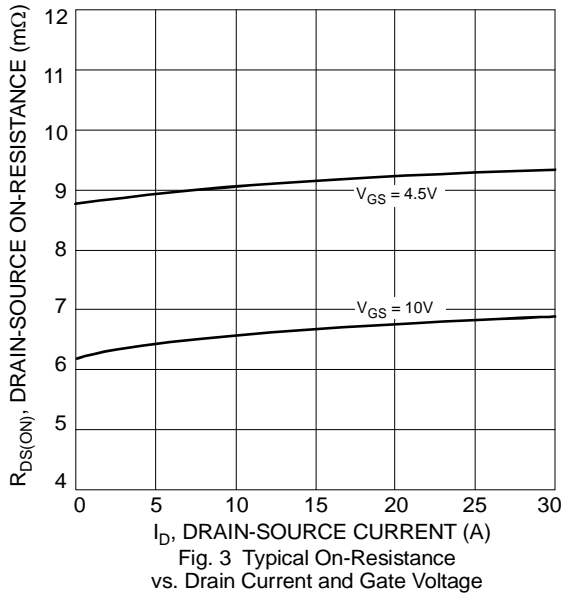

Fig. 2 Typical Transfer Characteristic



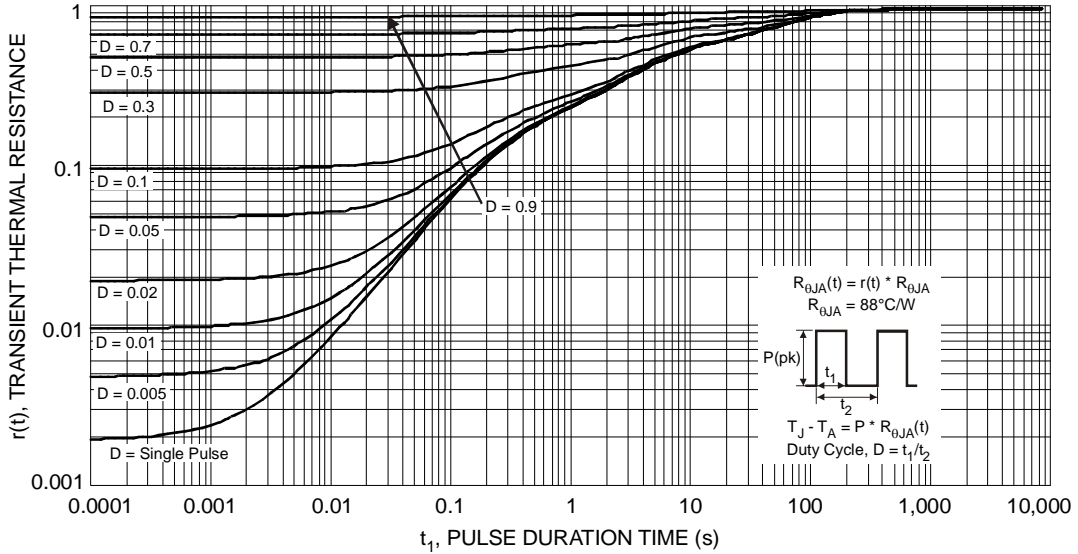

Fig. 9 Transient Thermal Response

**Ordering Information** (Note 6)

Part Number	Case	Packaging
DMN3007LSS-13	SOP-8L	2500/Tape & Reel

Notes: 6. For packaging details, go to our website at <http://www.diodes.com/datasheets/ap02007.pdf>.

**Marking Information**

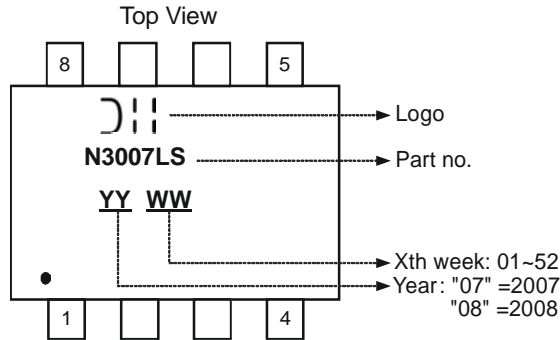

**Package Outline Dimensions**

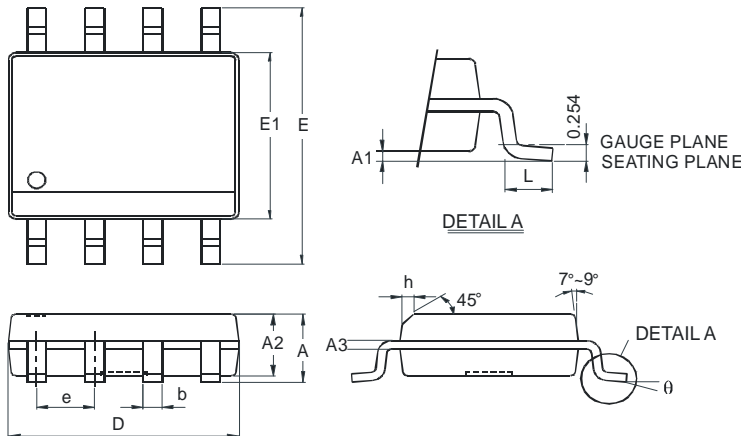

SOP-8L		
Dim	Min	Max
A	-	1.75
A1	0.08	0.25
A2	1.30	1.50
A3	0.20	Typ.
b	0.3	0.5
D	4.80	5.30
E	5.79	6.20
E1	3.70	4.10
e	1.27	Typ.
h	-	0.35
L	0.38	1.27
θ	0°	8°
All Dimensions in mm		

**Suggested Pad Layout**

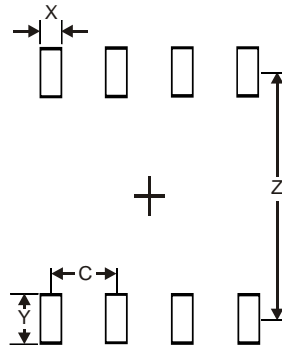

Dimensions	Value (in mm)
Z	5.1
C	1.27
X	0.41
Y	1.0

**IMPORTANT NOTICE**

Diodes Incorporated and its subsidiaries reserve the right to make modifications, enhancements, improvements, corrections or other changes without further notice to any product herein. Diodes Incorporated does not assume any liability arising out of the application or use of any product described herein; neither does it convey any license under its patent rights, nor the rights of others. The user of products in such applications shall assume all risks of such use and will agree to hold Diodes Incorporated and all the companies whose products are represented on our website, harmless against all damages.

**LIFE SUPPORT**

Diodes Incorporated products are not authorized for use as critical components in life support devices or systems without the expressed written approval of the President of Diodes Incorporated.